

# FALLING WEIGHT DEFLECTOMETER FWD / HWD

## RINCENT HEAVYDYN



Version 4 : 22/12/2023



# 1 FWD/HWD trailer

The Rincent FWD Heavydyn (Falling Weight Deflectometer) is a single axis trailer to measure deflection using a dynamic load for road and airport platforms.

It features very compact dimensions with a foldable hitch, a fast measurement time using high power hydraulic system and intuitive acquisition software for tactile tablet.

The trailer is configurable in a FWD (Falling Weight Deflectometer) with 300 kg of drop weight for road use up to 120kN and in a HWD (HeavyWeight Deflectometer) with 600kg of drop weight for airport use up to 250kN.



**Trailers assembly in our Paris facility.**

## 1.1 Trailer configuration

The Heavydyn trailer is a foldable single axis trailer that is fully compliant with EU and Worldwide Road regulations.

Equipment's on the trailer are fully enclosed to provide strong protection against environmental aggression.

it is also fully contained with all the necessary equipment to perform measurements and no additional hardware on the supporting vehicle is required.



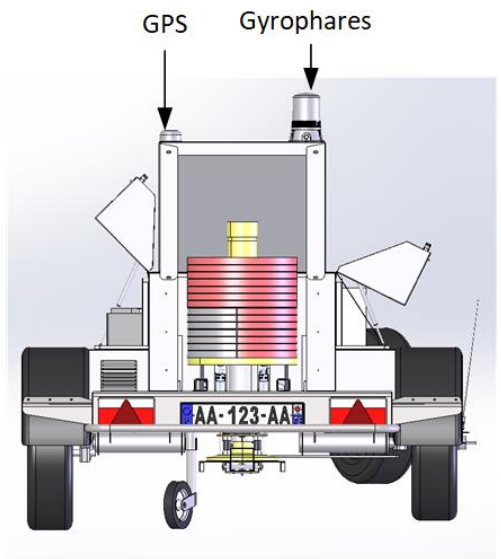
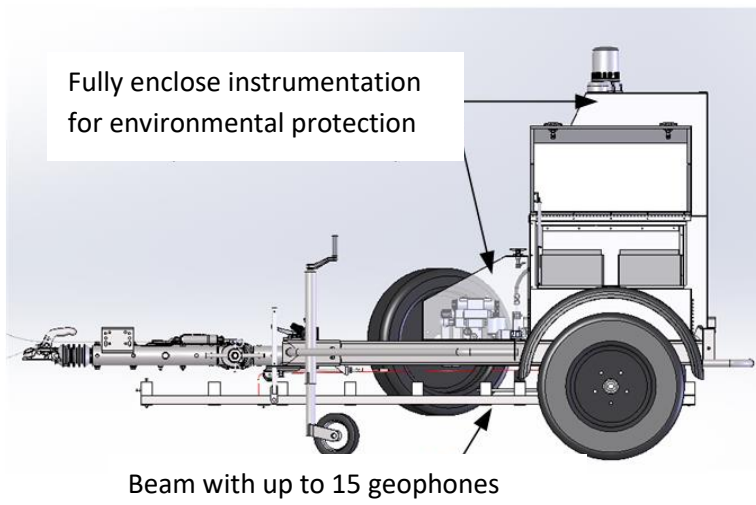
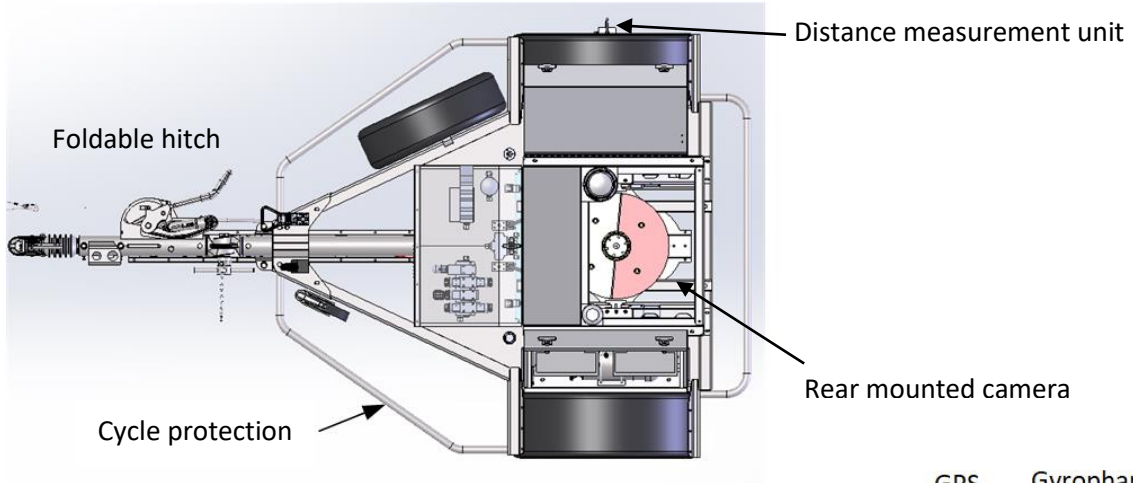

**Figure 1 : Trailer 3D view.**

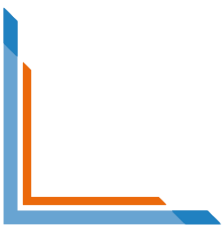





## 1.2 Power

A high power, high speed hydraulic system is used to control the movement of the beam and weight during measurement.

Typical road sequence is performed in approximately 20 seconds and airports sequence in ~30 seconds.

Energy for measurement and hydraulic control system is provided by two 12V batteries that are recharged either by the vehicle alternator or an external generator.

## 1.3 Sensors

The FWD Heavydyn measurement system supports the followings sensors:

- A calibrated 350kN load cell on the lad plate
- Up to 15 geophones can be used on the measurement bar at distances from -30 cm to 210 cm in FWD configuration and -45 cm to 2100mm in HWD configuration
- Two thermometers are installed to measure the air and surface temperatures.

## 1.4 Impact configuration

The drop height is controlled by software to achieve a 40 – 150 kN (FWD configuration) or 80-250 KN (HWD configuration) impact on the road.

Two buffers configuration can be used to tune the impact loading time to 25 to 30 ms.



**Trailer in FWD configuration (left) and HWD (right)**

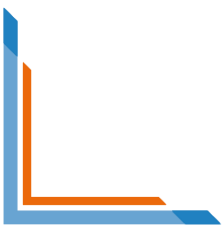



## 1.5 Georeferencing

The measurements are georeferenced by two means:

- A DMI (linear distance coder) is installed on the left wheel of the FWD to display the distance.
- A GPS located on the top the trailer to obtain an absolute position.

Optionally the GPS can be purchased with a DGPS subscription to obtain sub metric positioning.

A camera is also installed at the rear of the trailer to show the plate position relative to the road.

## 1.6 Mechanical

The following figure gives a schematic view of the mechanical system of the material.

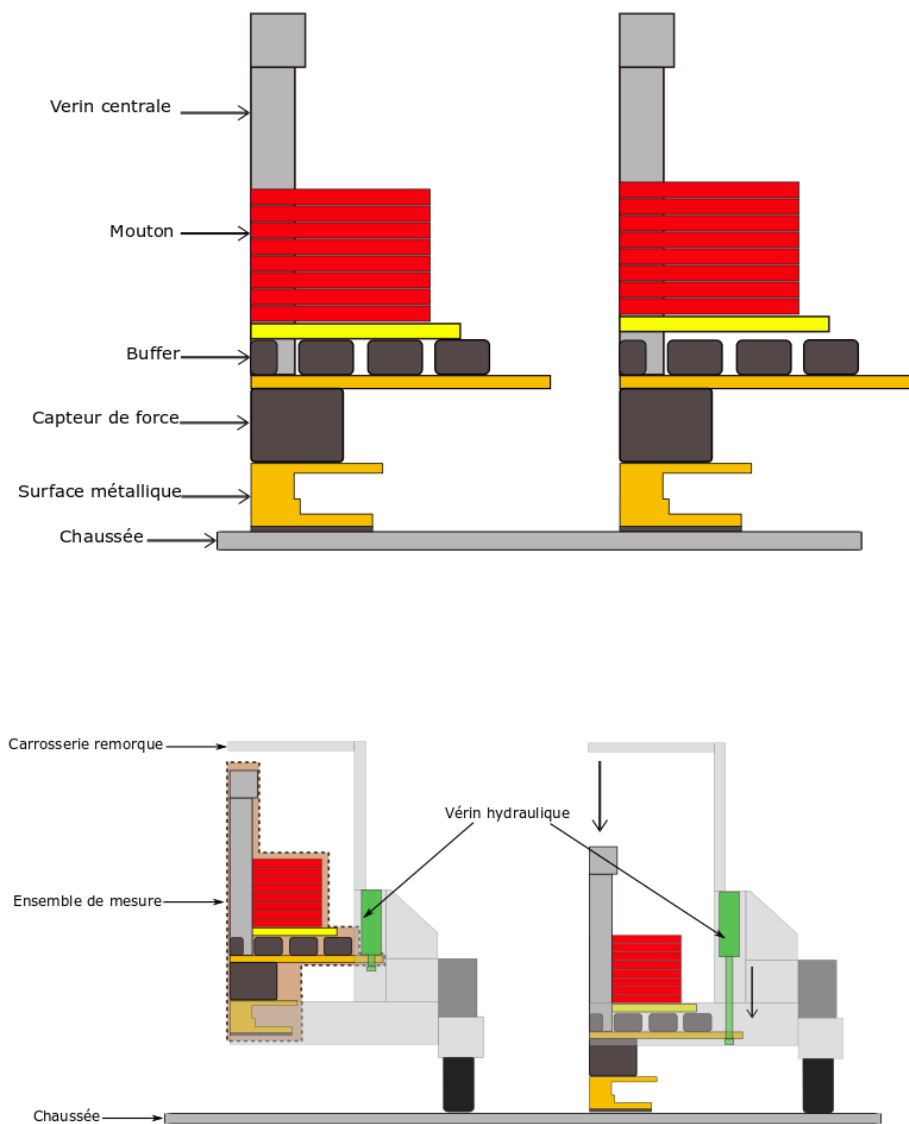

**Schematics mechanical principle**

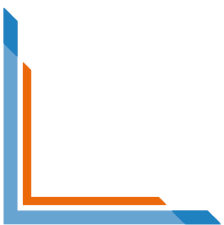



## 1.7 Light Signalling

The trailer comes originally with a yellow flashing gyro. You can add as an option:

- An LED ramp with a scrolling arrow, two lights and two flash lights
- A bar with panel light works and two lights



**Bar with light panel.**



**LED ramp with scrolling arrow.**

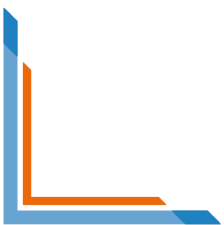

## 1.8 Technical characteristics

Specifications	Value
<b>Trailer type</b>	FWD and HWD
<b>Dimensions (unfolded)</b>	(l) 3,50 m x (w) 1,70 m x (h) 1,70 m
<b>Dimensions (folded)</b>	(l) 3.00 m x (w) 1,70 m x (h) 1,20 m
<b>Falling weight mass</b>	300 kg (FWD) 600 kg (HWD)
<b>Trailer weight</b>	980 kg (FWD) 1300 kg (HWD)
<b>Drop height</b>	50 cm
<b>Impact load (FWD)</b>	30 - 150 kN
<b>Impact load (HWD)</b>	50 – 250 kN
<b>Displacement sensors geophones</b>	Up to 15 geophones from -450 mm to 2100 mm Side geophones for load transfer efficiency (LTE) Frequency range: 4.5 Hz...2500 Hz Resolution: 0.1µm Precision: less than 1%
<b>Load cell</b>	350 kN (~35T) load cell Resolution: 100 N Precision: less than 1%
<b>3 impacts times @ 65 kN</b>	22 s.
<b>Power</b>	Onboard batteries 24V Recharge by vehicle alternator or an external generator
<b>Data transfers</b>	Over ethernet cable
<b>Acquisition</b>	16 channels 16bit ADC acquisition Up to 30 000 Hz acquisition frequency Up to 4000 data points per acquisition Up to 500 msec data history per channel
<b>Geolocalisation</b>	DMI: 1% precision après calibration GPS: GPS, GLONASS + SBAS, up to 1m precision DGPS option for submetric positioning
<b>Camera</b>	On USB HD camera. Shown on acquisition software
<b>Temperature</b>	Air and surface temperature Manuel temperature can be saved manually in software



## 2 Vehicle installation

The FWD/HWD can be installed on any vehicle equipped with a 50mm hitch ball and with sufficient traction capacity for the weight of the trailer (1300kg in HWD version).

The internal batteries of the trailer allow use without recharging for about one hour. For continued use, a charging device must be installed.

The equipment battery recharge is either:

- Performed by standard 220V AC outlet to achieve continuous operation
- Performed by a generator installed on the FWD trailer.

Installation in the vehicle consists of:

- Add power harness from vehicle alternator to hitch ball
- Add in cab support for 10 inch laptop and camera
- Two days of immobilization of the vehicle must be provided for the installation

## 3 Calibration

An absolute calibration is done before delivery for every sensor, load cell, geophones, dmi and thermometers, on the trailer using traceable calibration reference.

The Rincent FWD Heavydyn complies with the following standards:

- ASTM D4694
- AASHTO R32
- UK Correlation trial
- CROW Correlation trial

In addition, user can check the calibration of the deflection sensors using a stack tower procedure.



**Figure 2 : Airport trials.**

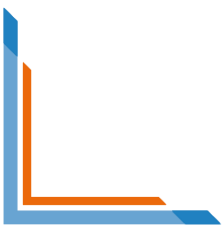



### 3. Softwares

#### 3.1 Fwddyn acquisition software

The Fwddyn software is an easy-to-use, touchscreen enabled, acquisition and reporting software for the Rincent FWD Heavydyn that can be installed on any Windows 10 laptop.

No license, driver or configuration and calibration files are required. Upon connexion to a Heavydyn trailer, the Fwddyn software download from the trailer control box the necessary calibration and trailer parameter.

The Fwddyn software can be configured to perform any type of drop sequences for a given project. Saved measurement include signals time history, geolocalisation, temperatures and calculated deflection data that can be exported directly on:

- Excel file using a user provided template.
- F25 or FWD text file to be used on retrocalculus software such as Alizé, Elmod or Rosy.

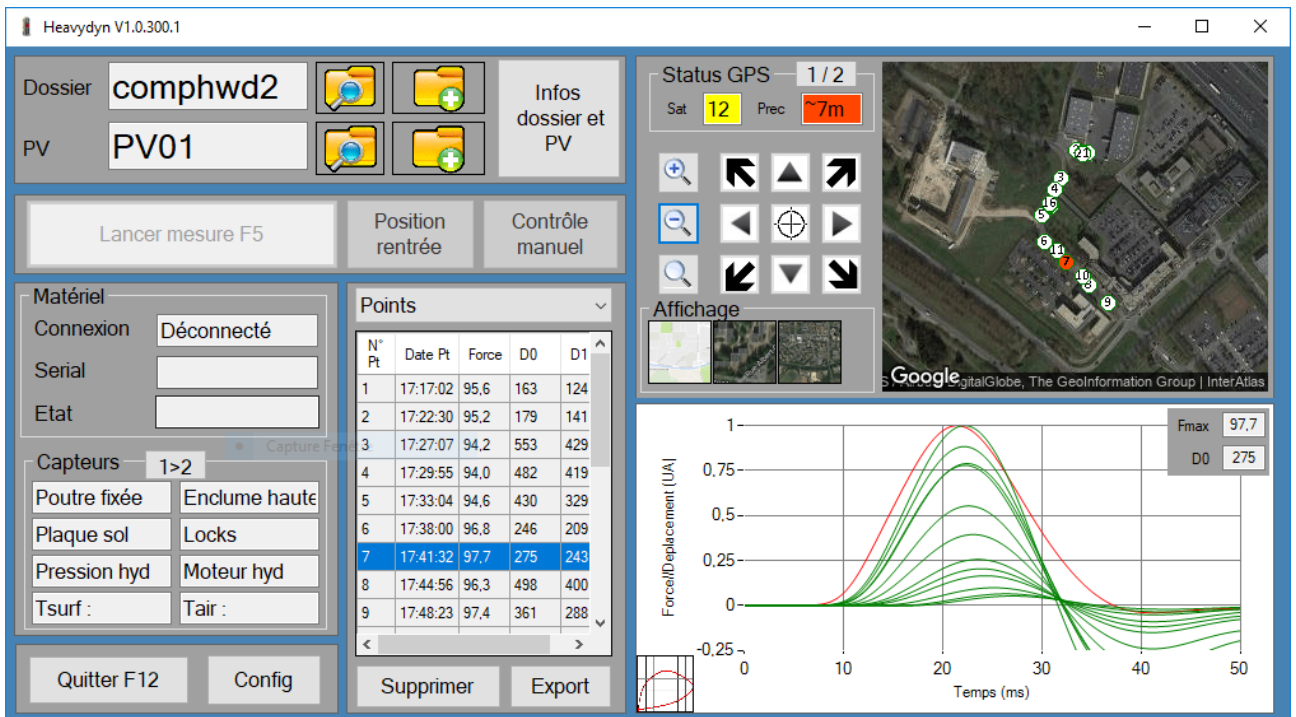

**FWDDYDYN acquisition software**

The FwdDyn software gives access to the complete configuration of the machine (sensor sensitivity, acquisition parameters).

The measurement files store all raw time data from all sensors and all keystrokes performed.

Logiciel Sequences Calibration ADC Ana Camera

Infos calibration  
Date: 20/06/2020  
Infos: Default values calibration

Paramètres acquisition  
Fréquence acquisition (Hz): 30000  
Nombre d'échantillons: 3000  
Temps minimum (ms): 0,000500000  
Durée prétrig (ms): 0,0049999998  
Force minimum (kN): 20000  
Voie trig: 0  
Dplaque (mm): 0,4499999880

Charger depuis Sauver dans fichier  
Sauver dans FWD

ID	Nom	Gain	V0
-1	DZWY	4,075E-008	0,000E+000
-2	FG256	2,863E+001	0,000E+000
-3	FG189	2,912E+001	0,000E+000
-4	FG211	2,964E+001	0,000E+000
-5	FG201	2,894E+001	0,000E+000
-6	FG216	2,889E+001	0,000E+000

Voie	ADC	Distance	Capteur
0	15	0 mm	DZWY
1	0	-300 mm	FG256
2	7	0 mm	FG189
3	2	300 mm	FG201
4	3	400 mm	FG216
5	4	600 mm	FG240
6	5	900 mm	FG244
7	6	1200 mm	FG200
8	10	1500 mm	FG257

Retour

### Access to sensor calibrations

Logiciel Sequences Calibration ADC Ana Camera

Nom	N° étape	Valeur lâcher	Type lâcher
UK-50KN	1	100 mm	Distance
UK-75KN	2	65,0 kN	Force
FR-60KN	3	65,0 kN	Force
FR-65KN	*		

Séquence par défaut: FR-65KN  
Séquence PV: [ ]

Retour

### Creation of test sequences

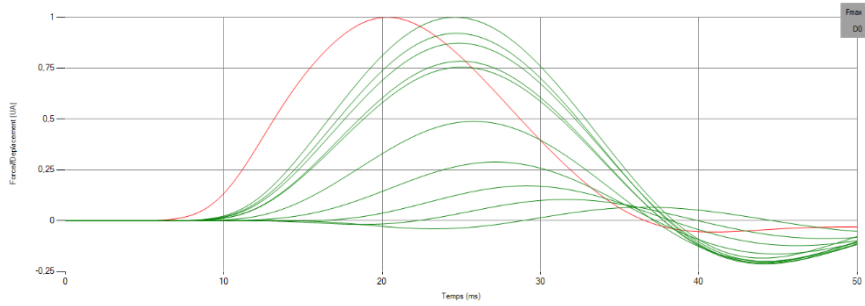

Typical time history measurement (red curve=load, greens curves=deflections)

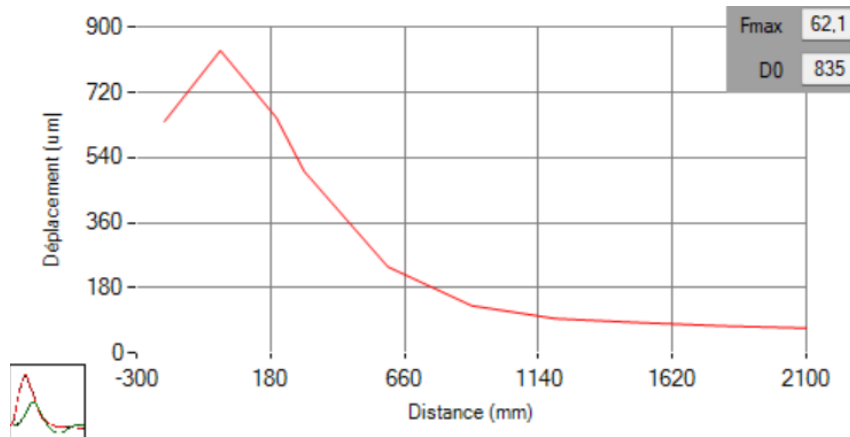

Deflection bowl

FwdDyn V1.2.23.0

Dossier: **First test** | Infos dossier et PV

PV: **AP CAL** | Infos dossier et PV

Position rentrée | Contrôle manuel

Poutre fixée

N° Pt	Date Pt	Force	D0	D1
1	10-10-23	60,0	207	180
2	11-07-30	60,9	256	186

Matériel: Connexion **Connecté**, Serial **FWD-107C**, Etat **Repos**

Capteurs: 1>2

- Poutre fixée
- Enclume haute
- Plaque sol
- Locks ouverts
- Mouton bas
- Moteur hyd
- Tsurf : 15,2°C
- Tair : 16,3°C

Quitter F12 | Config | Supprimer | Export

RAZ | 0 m | Sat **0** | Prec **No Fix**

On screen camera

### 3.2 Mapping software

The Mapview website offer a state-of-the-art powerful visualization tool that can display thousands of data points at a glance. Users can immediately see the weaker and stronger part of the pavement under test using the threshold feature.

The Mapview website is available, free of charge, for visualizing and exporting on Excel FWD projects and can be used on any device and operating system, laptop, phone, tablet, Windows, MacOS, Andoid.

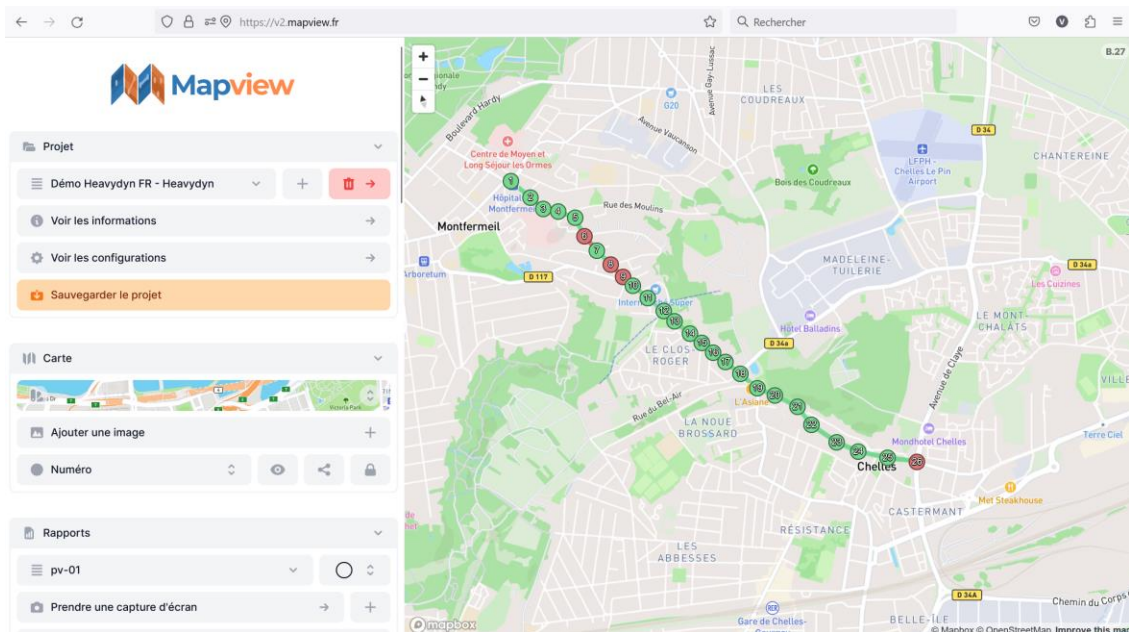

**Application web Mapview**

Measurements can be exported in different formats :

- Export according to user's Excel template
- Export database in CVS text format

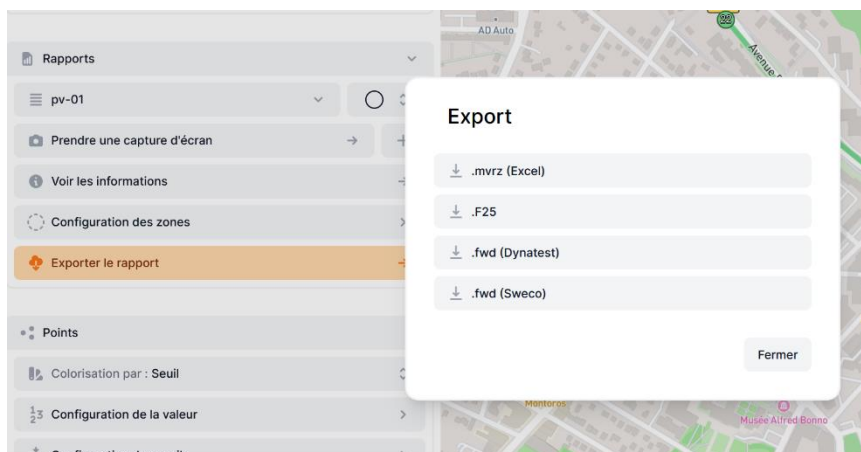

**Export available**





### Essais relatifs aux chaussées

Déflexion au déflectomètre à masse tombante (FWD)

INFORMATIONS GENERALES			
Nom chantier :	marne et gondoire	Date de rapport :	27/01/2021
Localisation :		N° de dossier :	
Client :		Demandeur :	

N° point	Localisation			Chargement			Déflexion (µm)													Rayon courbure (m)	Etat du support / dégradations
	Chainage (m)	Longitude	Latitude	Charge (kN)	Temps impact (ms)	Pression (MPa)	d <sub>1000</sub>	d <sub>0</sub>	d <sub>2000</sub>	d <sub>3000</sub>	d <sub>4000</sub>	d <sub>5000</sub>	d <sub>6000</sub>	d <sub>7000</sub>	d <sub>8000</sub>	d <sub>9000</sub>	d <sub>10000</sub>	d <sub>11000</sub>	d <sub>12000</sub>		
1	34	2,684420	48,876905	154,0	20	2,18	1032	688	531	531	253	368	253	196	152	122	2070				
2	51	2,685082	48,877051	157,1	20	2,22	474	316	266	266	199	228	199	180	157	143	6500				
3	101	2,685738	48,877185	156,1	20	2,21	482	321	275	275	225	252	225	192	165	148	7065				
4	152	2,686400	48,877318	151,8	21	2,15	1019	679	583	583	77	234	77	54	44	36	3385				
5	200	2,687024	48,877458	152,4	20	2,16	488	325	251	251	199	221	199	186	165	150	4392				
6	253	2,687696	48,877608	153,7	20	2,17	420	280	226	226	133	160	133	123	110	100	6019				
7	300	2,688311	48,877727	154,8	20	2,19	458	305	218	218	115	141	115	103	92	82	3736				
8	0	2,687878	48,877664	149,6	21	2,12	1290	860	736	736	448	592	448	341	244	178	2621				
9	50	2,687080	48,877491	150,3	21	2,13	1184	789	707	707	490	604	490	394	301	220	3963				
10	55	2,686369	48,877334	148,6	21	2,10	1347	898	767	767	478	620	478	368	267	192	2481				
11	102	2,685774	48,877210	147,1	21	2,08	1574	1049	874	874	465	582	465	339	249	179	1857				
12	154	2,685097	48,877081	145,6	22	2,06	2376	1584	1525	1525	639	917	639	450	312	184	5508				
13	194	2,684534	48,877002	149,5	21	2,11	1131	754	644	644	299	496	299	247	193	144	2955				
14	260	2,684208	48,877520	152,0	21	2,15	642	428	358	358	209	273	209	162	123	89	4643				
15	53	2,683522	48,877384	151,5	21	2,14	434	289	243	243	178	210	178	153	127	108	7065				
16	102	2,682911	48,877214	152,5	21	2,16	396	264	266	266	125	154	125	118	103	91	4521				
17	152	2,682293	48,877002	149,1	21	2,11	1121	747	477	477	220	307	220	180	147	127	1204				
18	199	2,681723	48,876819	147,7	21	2,09	861	574	469	469	289	382	289	230	185	152	3095				
19	253	2,681034	48,876672	151,1	21	2,14	270	180	163	163	142	153	142	138	123	110	19118				
20	301	2,680428	48,876504	150,2	21	2,12	359	239	217	217	180	197	180	165	141	119	14773				
21	351	2,679786	48,876335	150,5	21	2,13	309	206	188	188	156	173	156	143	124	114	18056				
22	421	2,678918	48,876090	149,1	22	2,11	651	434	352	352	222	277	222	177	150	127	3963				



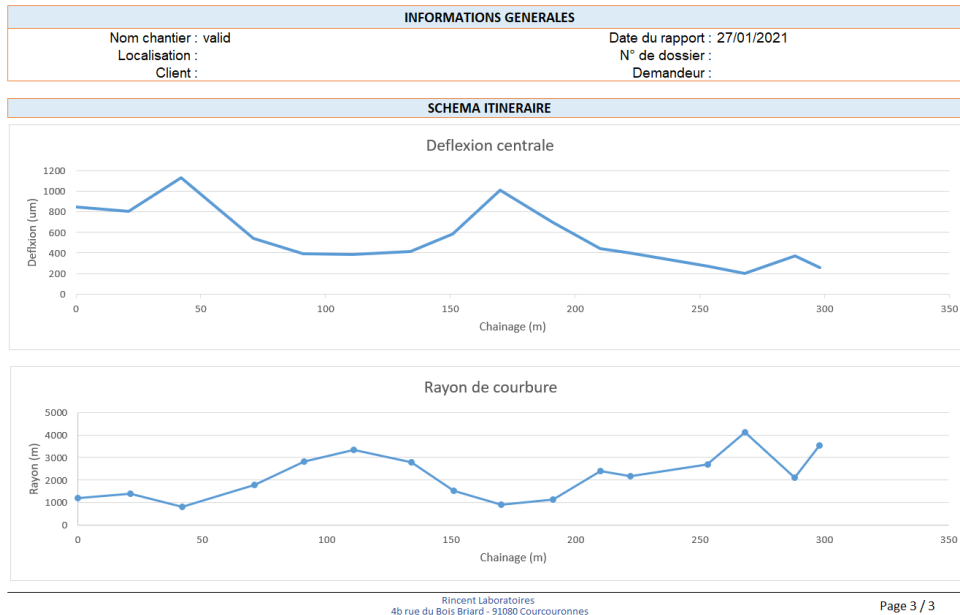

## Exports Exemples

### 3.1 Exploitation des résultats par retro calcul

The exported data is compatible with the following retrocalculus software :

- ELMOD 'Evaluation of Layer Moduli and Overlay Design'. Design'
- ROSY Compaction
- ALYZE
- PREDIWARE

Output data (including F25) can be imported by Alize LCPC and Elmod.

The Alize software with the Retrocalcul module allows an exploitation of the deflection basin and the obtaining of module by layer using a Burminster model.

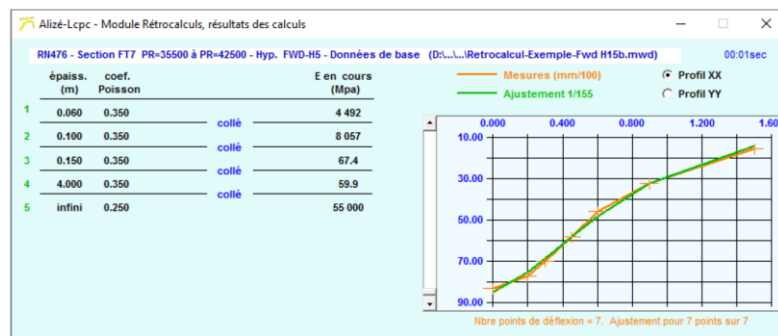

Module Rétrocalculs- Ecran de comparaison entre bassins mesuré et rétrocalculé  
Option de calcul n°1 (algorithme de descente)



### 3.4 Subsequent Software Installation

An identifier is provided to access the download page of the Rincent ND website Technologies. The software can be installed freely on an unlimited number of PCs. Software updates are free and available without time limits.

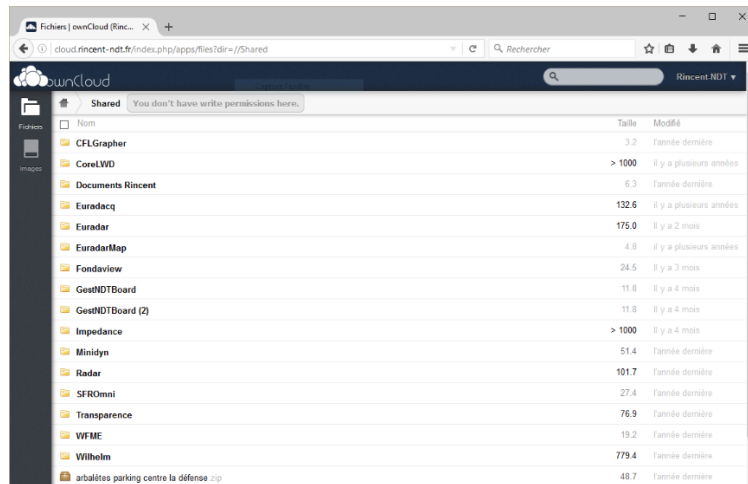

"Cloud" download page

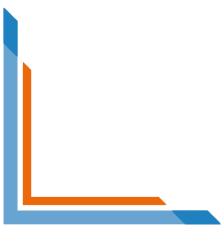



## 4 Warranty and after-sales service

The equipment and its accessories are guaranteed one year parts and labor. Updates to acquisition and export software are included without time limit. Our workshop in Courcouronnes in Ile de France performs the maintenance of most trailers and instrumented vehicles used for road or airport roadway testing. Our team is able to carry out the after-sales service by phone or at your workplace in France or at you facility.



Lift measurement equipment manufactured by Rincent ND Technologies.

## 5 Training

Training can be customized per customer need. A tailored program will be made for each individual customer requirement.

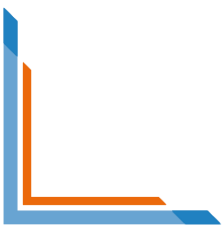



## CONTACT

 [ndt@rincent.fr](mailto:ndt@rincent.fr)

 +33 6 61 18 87 63

 4 bis rue du bois briard  
91080 Courcouronnes



The appearance of the products and/or technical characteristics are subject to change without notice.

